

1100x1100



Insulated container for the transport of temperature-controlled products











- Brand: MELFORM
- Country of origin: ITALY
- Customs code: 39231090
- External dimensions 1100x1100
- Compatible with food contact
- Color: grey/blue
- Capacity: 1350 liters.
- Technology: rotomoulding
- Warranty: 24 months
- Fully recyclable at the end of its operational life.

MANUFACTURING MATERIALS

Polyethylene	inner and outer walls of container and door; suitable for food contact	Polyurethane	insulating material between the walls of the container and the door, free of CFC and HCFC
Silicone rubber	gasket	Nylon	wheels
Polypropylene	Hinges	Stainless steel	handling handles, closing handle, internal door rod
Galvanized steel	Hinge rods, hinge rod connection plates, wheel support		

Model	Code	EAN code	Ext. dim. (mm)	Int. dim. (mm)	Capacity (liters)	Weight (kg)
Cargo 1300 TW Basic	1300T907	8022949229221	1100x1100x1780	900x910x1580	1350	145,5
Cargo 1300 TW wheels	1300T003	8022949120610	1100x1100xh1940	900x910xh1580	1350	150
Cargo 1300 TW feet	1300T009	8022949138202	1100x1100xh1905	900x910xh1580	1350	150

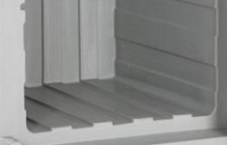
PRODUCT FEATURES

	Equipped with 4 wheels. diam. 125mm, two fixed, one swivel and one swivel with brake. Wheel support plate integrated in the container		Version with 4 feet in galvanized steel h 120mm
	4 housing seats of grids positioned at 385/785/1185/1290mm from the bottom of the container		Stainless steel grids (on request)
	Card holder for identification of the content or destination. Suitable for B5 format documents		Stainless steel closing handle with release button and tamper-evident system
	Controllable internal temperature thanks to the thermometer that can be inserted into the door (on request)		Available (on request) USB datalogger to record temperature data during transport
	2 stainless steel seats, positioned 135mm from the roof of the container, allow the housing of 4 eutectic plates		Fresh, frozen and frozen plus eutectic plates, to increase thermal performance over time (on request)
	Door can be opened up to 270° with double tab and magnetic door retainer		Door sealing gasket easily removable
	Internal grooves to promote good air circulation		Double pin hinges. Improved stability of the door over time
K	Overall heat transfer coefficient: K=0.33 W/m²K	°C	Guaranteed for use: -30°C to +100°C

TECHNICAL DATA (mm)

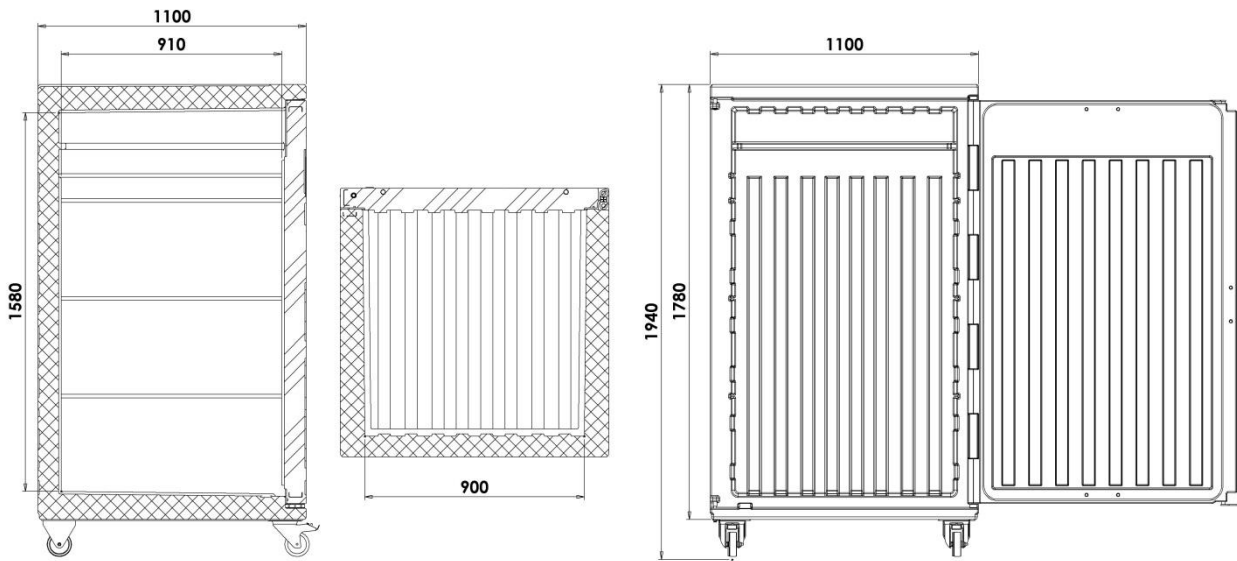

ACCESSORIES

Model	Code	Color	Ext. dim. (mm)	Weight (kg)
Card holder	RRI244		B5	
Stainless steel grid	AEA024		935x890xh16	7
Eutectic plate Fresh +3°C - 4 x Cargo -	PE110001	rose	835x353xh45	7,6
Eutectic plate Frozen -21°C - 4 x Cargo -	PE110002	blue	835x353xh45	7,6
Eutectic plate Frozen Plus -21°C - 4 x Cargo -	PE119008	green	835x353xh45	7,6
USB Data Logger Range -30°C +70°C	AFG007		80x33xh14	
Floor/vehicle container fixing kit (for Basic version)	RRI223			
Eutectic plate retainer safety kit	RRI180			
Analog thermometer +40°C- 40°C	RRI165			