



**80x120**

**ATP**



## Isothermal container for the transport of products at controlled temperatures













- Brand: MELFORM
- Country of origin: ITALY
- Customs code: 39231090
- **ATP Certificate**
- EUROPALLET internal dimensions
- Compatible with food contact
- Color: Grey/Blue
- **Capacity: 1350 litres.**
- Technology: rotational
- Warranty: 24 months
- Fully recyclable at end of operating life.

### MANUFACTURING MATERIALS

<b>Polyethylene</b>	internal and external walls of the container and door; suitable for food contact	<b>Polyurethane</b>	insulating material between the walls of the container and the door, free of CFCs and HCFCs
<b>Silicone rubber</b>	gasket	<b>Polypropylene</b>	hinges
<b>Galvanized steel</b>	metal feet, hinge rods, hinge rod connection plates, wheel support	<b>Nylon</b>	wheels
<b>Stainless steel</b>	operating handles, closing handle, internal door rod		

Model	Code	EAN code	External dimensions (mm)	Internal dimensions (mm)	Capacity (the)	Weight (Kg)
Cargo 1300 <b>Basic</b>	13019034	8022949200213	985x1405x1525	810x1210x1340	1350	148.5
Cargo 1300 <b>with wheels</b>	13019009	8022949143794	985x1405xh1695	810x1210xh1340	1350	153
Cargo 1300 <b>with feet</b>	13010003	8022949137212	985x1405xh1646	810x1210xh1340	1350	153

**PRODUCT FEATURES**

	<p>Version with 6 galvanized steel feet h 120 mm</p>		<p>Version with wheels: 4 wheels with a diameter of 125 mm (2 fixed and 2 swivel, one with brake). Wheel support plate integrated into the container</p>
	<p>Euro pallet size drip collector</p>		<p>Double pin hinge system. Better door stability over time</p>
	<p>Door opens up to 270° with tongue door stop</p>		<p>Stainless steel locking handle with release button</p>
	<p>Handle designed for use with anti-tamper system.</p>		<p>Fresh, frozen and frozen plus eutectic plates to increase thermal maintenance performance over time</p>
	<p>Eutectic plate safety kit.</p>		<p>Thermometer inserted into the door (on request).</p>
	<p>USB datalogger to record temperature data during transport</p>		<p>RFID systems for traceability</p>
<p><b>K</b></p>	<p>Overall heat transfer coefficient: <b>K=0.35 W / m<sup>2</sup>K</b></p>	<p><b>°C</b></p>	<p>Guaranteed for use: <b>from -30°C to +100°C</b></p>

## TECHNICAL DATA (mm)

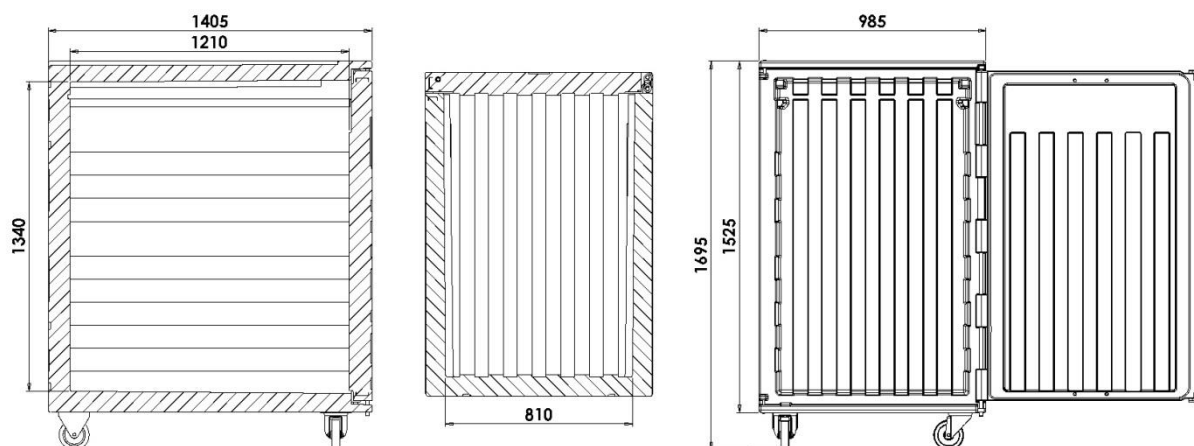

Wheel version

## ACCESSORIES

Model	Code	Color	External dimensions (mm)	Weight (Kg)
Plastic card holder	RRI141		A5	
Pallet Drip collector	ANA00101	blue	800x1200xh200	16
Eutectic plate <b>Fresh +3°C</b> - 3 x Cargo -	PE110001	rose	835x353xh45	7.6
Eutectic plate <b>Frozen -21°C</b> - 3 x Cargo -	PE110002	blue	835x353xh45	7.6
Eutectic plate <b>Frozen Plus -21°C</b> - 3 x Cargo -	PE119008	green	835x353xh45	7.6
USB Data Logger -30°C +70°C	AFG007		80x33xh14	
Ground safety fixing kit (for Basic version)	RRI223			
Eutectic plate retainer kit	RRI180			
Analogue thermometer +40°C- 40°C	RRI165			