

1100x1100



Insulated container for the transport of temperature-controlled products













- Brand: MELFORM
- Country of origin: ITALY
- Customs code: 39231090
- External dimensions 1100x1100
- Compatible with food contact
- Color: grey/blue
- Capacity: 1350 liters.
- Technology: rotomoulding
- Warranty: 24 months
- Fully recyclable at the end of its operational life.

MANUFACTURING MATERIALS

| | | | |
|-------------------------|--|------------------------|---|
| Polyethylene | inner and outer walls of container and door; suitable for food contact | Polyurethane | insulating material between the walls of the container and the door, free of CFC and HCFC |
| Silicone rubber | gasket | Nylon | wheels |
| Polypropylene | Hinges | Stainless steel | handling handles, closing handle, internal door rod |
| Galvanized steel | Hinge rods, hinge rod connection plates, wheel support | | |

| Model | Code | EAN code | Ext. dim. (mm) | Int. dim. (mm) | Capacity (liters) | Weight (kg) |
|-----------------------------|----------|---------------|-----------------|----------------|-------------------|-------------|
| Cargo 1300 TW Basic | 1300T907 | 8022949229221 | 1100x1100x1780 | 900x910x1580 | 1350 | 145,5 |
| Cargo 1300 TW wheels | 1300T003 | 8022949120610 | 1100x1100xh1940 | 900x910xh1580 | 1350 | 150 |
| Cargo 1300 TW feet | 1300T009 | 8022949138202 | 1100x1100xh1905 | 900x910xh1580 | 1350 | 150 |

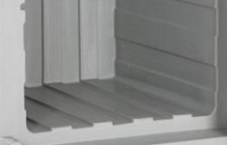
PRODUCT FEATURES

| | | | |
|---|---|--|---|
|  | Equipped with 4 wheels. diam. 125mm, two fixed, one swivel and one swivel with brake. Wheel support plate integrated in the container |  | Version with 4 feet in galvanized steel h 120mm |
|  | 4 housing seats of grids positioned at 385/785/1185/1290mm from the bottom of the container |  | Stainless steel grids (on request) |
|  | Card holder for identification of the content or destination. Suitable for B5 format documents |  | Stainless steel closing handle with release button and tamper-evident system |
|  | Controllable internal temperature thanks to the thermometer that can be inserted into the door (on request) |  | Available (on request) USB datalogger to record temperature data during transport |
|  | 2 stainless steel seats, positioned 135mm from the roof of the container, allow the housing of 4 eutectic plates |  | Fresh, frozen and frozen plus eutectic plates, to increase thermal performance over time (on request) |
|  | Door can be opened up to 270° with double tab and magnetic door retainer |  | Door sealing gasket easily removable |
|  | Internal grooves to promote good air circulation |  | Double pin hinges. Improved stability of the door over time |
| K | Overall heat transfer coefficient: K=0.33 W/m²K | °C | Guaranteed for use: -30°C to +100°C |

TECHNICAL DATA (mm)

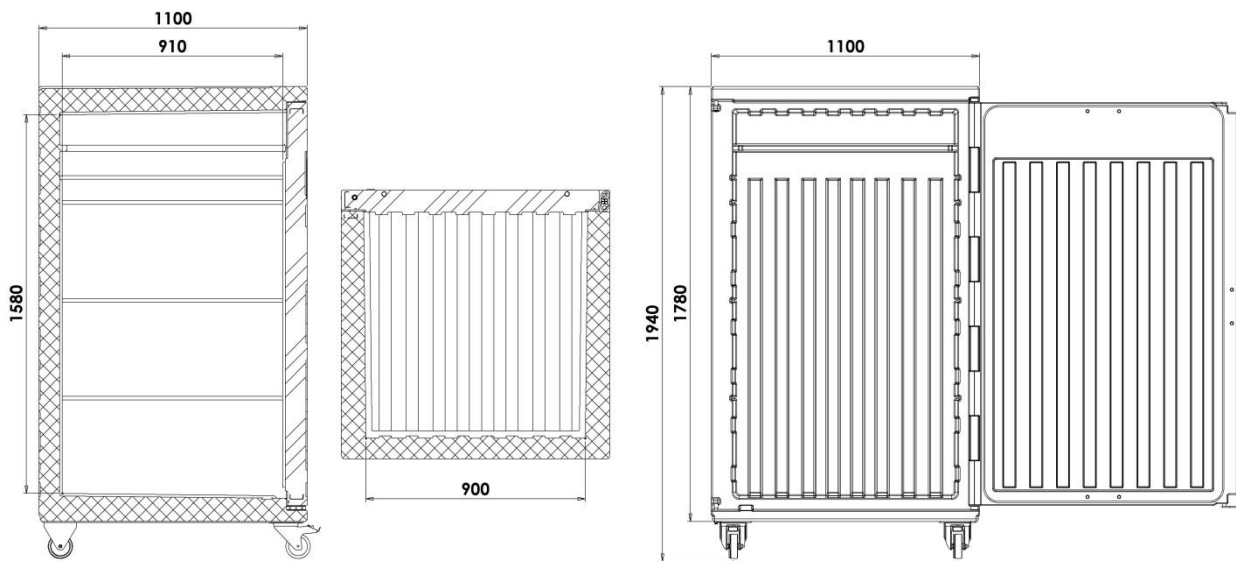

ACCESSORIES

| Model | Code | Color | Ext. dim. (mm) | Weight (kg) |
|--|----------|-------|-------------------|----------------|
| Card holder | AMC103 | | B5 | |
| Stainless steel grid | AEA024 | | 935x890xh16 | 7 |
| Eutectic plate Fresh +3°C - 4 x Cargo - | PE110001 | rose | 835x353xh45 | 7,6 |
| Eutectic plate Frozen -21°C - 4 x Cargo - | PE110002 | blue | 835x353xh45 | 7,6 |
| Eutectic plate Frozen Plus -21°C - 4 x Cargo - | PE119008 | green | 835x353xh45 | 7,6 |
| USB Data Logger Range -30°C +70°C | AFG007 | | 80x33xh14 | |
| Floor/vehicle container fixing kit (for Basic version) | RRI223 | | | |
| Eutectic plate retainer safety kit | RRI180 | | | |
| Analog thermometer +40°C- 40°C | RRI165 | | | |