



GN 1/1



Insulated container with front opening for the transport of products at controlled temperature

- Brand: MELFORM
- Country of origin: ITALY
- Customs code: 39231090
- Compatible with food contact
- Color: grey/blue, red, blue
- Capacity: 63 liters.
- Technology: roto moulding
- Warranty: 24 months
- Fully recyclable at the end of its operational life.
- Stackable and easy to move

MANUFACTURING MATERIALS











Polyethylene	Inner and outer walls of the container and door. Suitable for food contact	Polyurethane	Insulating material between the walls of the container and the door; CFC and HCFC free
Silicone rubber	Gasket	Glass fiber reinforced polyamide	Hinges
Stainless steel	Grip handles, closure	Acetal resin POM	Handle covers

Model	Code	EAN code	Ext. dim. (mm)	Int. dim. (mm)	Capacity (l)	Weight (Kg)
AF7 grey/blue	AF070006	8022949032982	440x640xh480	325x540xh360	63	11
AF7 blue	AF070001	8022949032937				
AF7 red	AF070004	8022949032968				

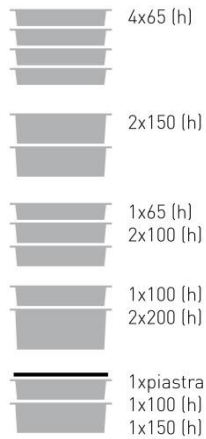

Via Savigliano 34 - 12030 Monasterolo di Savigliano (CN) ITALIA
 Tel. +39 0172812600 - info@melform.com
www.melform.com

PRODUCT FEATURES

	<p>7 internal runners with differentiated pitch (see dimensional diagram).</p>		<p>Adjustable vent valve.</p>
	<p>Equipped with opening door up to 240° and easily removable, to facilitate washing operations.</p> <p>Easily dismantled door sealing gasket.</p>		<p>Stainless steel closing hooks.</p>
	<p>Stainless steel grip handles with handle cover</p>		<p>Equipped with hinges in shockproof and resistant to stress.</p>
<p>°C</p>	<p>Container granted for use: from -30°C to +100°C</p>		<p>Available (on request) USB datalogger to record temperature during transport</p>
	<p>It can carry GN 1/1 pans with different height:</p> <ul style="list-style-type: none"> • 4 pc h 65 • 2 pc h 150 • 1 pc h 65 + 2 pc h 100 • 1 pc h 100 + 2 pc h 200 • + 1 eutectic plate + 1 pc h 100 + 1 pc h 150 		<p>Smartdolly trolley:</p> <ul style="list-style-type: none"> • capacity 150 Kg • 4 non-marking rubber wheels and PP core • diam wheels: 100 mm • 2 fixed wheels • 2 swivel wheels. <p>Available with chromed, stainless-steel or without handle</p>
	<p>Available (on request) heating door, in analog or digital version, to extend the time of transport in hot bond:</p> <ul style="list-style-type: none"> • power 200W • cable 240V l=2 mt • IPX4 • heating unit with stainless steel interior 		<p>Eutectic plates to increase maintenance performance thermal over time:</p> <ul style="list-style-type: none"> • warm (red) • fresh (pink) • frozen (blue) • frozen plus (green grey)

TECHNICAL DATA (mm)

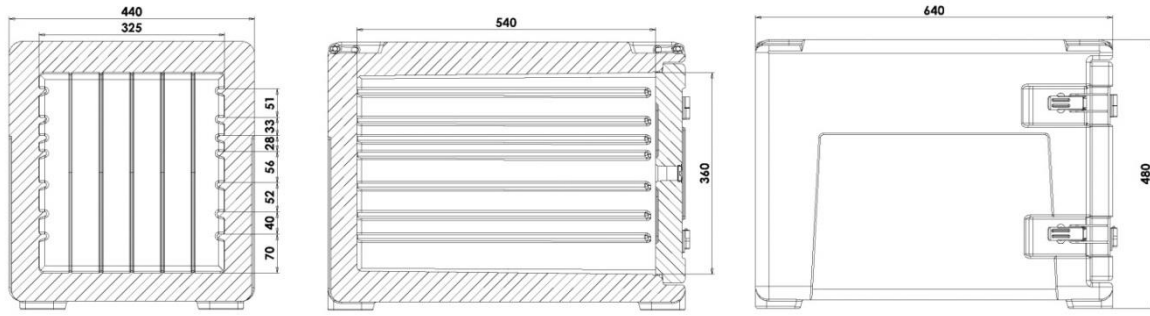

ACCESSORIES

Model	Code	Color	Ext. Dim. (mm)	Weight (Kg)
Eutectic plate Hot +70°C	PEGS0003	red	GN 1/1	3
Eutectic plate Fresh +3°C	PEGS0001	pink	GN 1/1	4
Eutectic plate Frozen -21°C	PEGS0002	blue	GN 1/1	4
Eutectic plate Frozen plus -21°C	PEGS9008	green	GN 1/1	4
Stainless steel grid	AEA020	stainless steel	GN 1/1	1,3
Smartdolly handling trolley stainless steel handle	MAXI0018	grey/blue	525x750xh965	9,5
Smartdolly handling trolley chrome handle	MAXI0019	grey/blue	525x750xh965	9,5
Smartdolly handling trolley without handle	MAXI9007	grey/blue	525x750xh210	7,1
USB Data logger -30°C +70°C	AFG007		80x33xh14	
Heating digital door 230V a.c.	3B3H0016	red	440x110xh395	3,9
Heating analog door 230V a.c.	3B3H0018	red	440x110xh395	3,9
Inverter 12V/230V	AHD001			